

Engine	Alternator	Generator Model	
Huachai Deutz HC12V132ZL-LAG1A	Leroy-Somer LSA 49.3 M6	FB688-D / Open	FC688-D / Silent

50Hz/1500R.P.M	3-Phase	Power Factor	Emissions
		Factor Cos $\Phi = 0.8$	N/A

RATINGS	Prime Power		Standby Power		Rated Current	Fuel Consumption @100% Load
	(PRP)		(ESP)		Amps	
Voltage (V)	kWe	kVA	kWe	kVA	(A)	L/h
380/220	550	688	600	750	1044.6	137.4
400/230	550	688	600	750	992.3	137.4
415/240	550	688	600	750	956.5	137.4

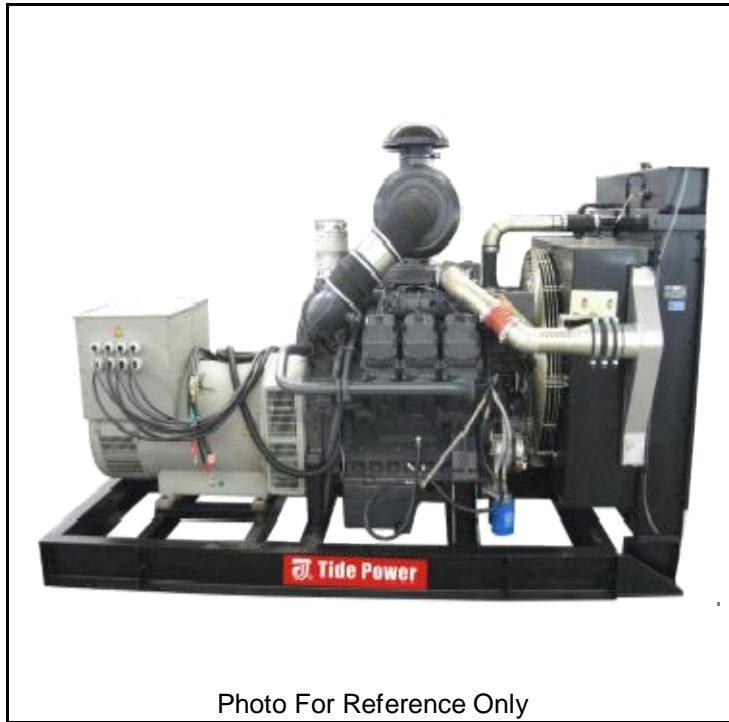

Key Features:

- High efficient water cooled diesel engine.
- Single bearing with brushless alternators (Class H, with AVR).
- Radiator with pressure cap and drain point.
- Fully guarded engine-driven fan.
- Fully welded steel skid base with lifting holes and fork lift legs.
- Integral fuel tank with filler cap and gauge ($\leq 650\text{kVA}$).
- Heavy duty rubber anti-vibration mountings.
- 12V or 24V maintenance free starter battery and connecting cables.
- Separate engine-driven battery charging alternator.
- Spin on oil and fuel filters and dry type air filter element.
- Industrial silencer (15dBA reduction) supplied loose.
- Auto start control system with LCD show.
- Battery charger provided.
- Main line 3P circuit breaker.
- Rigorous factory test wiring with IEC standard.
- Operation & Maintenance manual & Wiring diagrams.
- Wide range of optional extra features available.

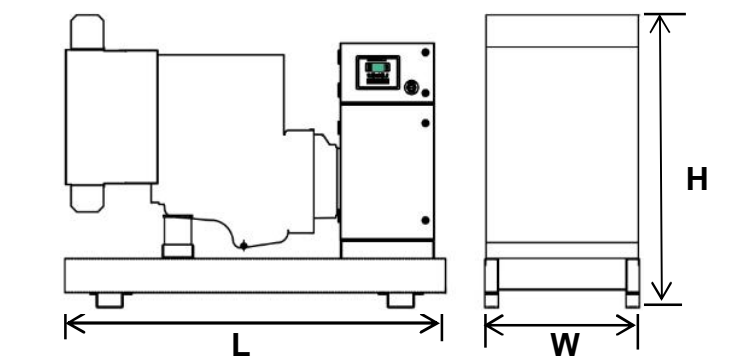

Overall Dimensions & Weights - Open Set

Length (L)-mm:	3700
Width (W)-mm:	1600
Height (H)-mm:	2200
Dry Weight-kg:	4200

Ratings: All three phase generator sets are rated at 0.8 power factor. All single-phase generator sets are rated at 0.8 or 1.0 power factor.
Prime Power: Available continuously at variable load in lieu of commercially purchased power for an unlimited number of hours per year accordance with ISO8528-1, and an overload of 10% permitted for one hour in every twelve hours of operation in accordance with ISO 3046-1.
Standby Power: Emergency Standby Power in variable load applications in accordance with ISO8528-1 in the event of a utility power failure.
 No overload available for this service as relevant alternators are peak continuous rated at 27 °C.
 TIDE Power reserves the right to change the design or specifications without notice and without any obligation or liability.





Engine **Huachai HC12V132ZL-LAG1A**

		Units	Prime	Standby
General Performance	Frequency	Hz	50	
	Engine Speed	r/min	1500	
	Cylinders / Type		12 cyl / in V form at angle of 90 / 4-stroke	
	Aspiration		Turbocharged	
	Governor Type		Electronic Governor	
	Bore / Stroke	mm	132/145	
	Displacement	Litres	23.812	
	Compression Ratio		16.5:1	
	Rotation Direction (From Flywheel Side)		Anti-clockwise	
	Engine Idle Speed	rpm	600 ±50	
	Engine Max.Power	kWm	670	
Fuel System	Fuel Consumption at 110% Prime Power	Litres/hour	151.1	
	Fuel Consumption at 100% Prime Power	Litres/hour	137.4	
	Fuel Consumption at 75% Prime Power	Litres/hour	110.0	
	Fuel Consumption at 50% Prime Power	Litres/hour	75.6	
	Fuel Consumption at 25% Prime Power	Litres/hour	41.2	
	Standard Fuel Tank Capacity	Hours / Litres	N/A	
Air System	Max. Allowable Intake Resistance	mbar	50	
	Turbocharger Inlet Size	mm	127	
	Volume of Air Intake (25°C/1000mbar)	m ³ /h	N/A	
Exhaust System	Max. Exhaust Back Pressure	mbar	50	
	Turbocharger exhaust flange inner diameter size	mm	117	
	Exhaust Gas Flow	kg/h	N/A	
	Max. Exhaust Temperature	°C	560	
Oil System	Oil Capacity-Initial Oil Filling	Litres	54	
	Oil consumption rate		<0.3% of Fuel Consumption	
	Oil Filter Element Type		Disposable Filter	
	No. of Oil Oilter Element		1	
Cooling System	Coolant Capacity - Engine Only	Litres	30	
	Open Temperature of the Two Thermostats	°C	79-87	
	Thermostat Open Temperature Both	°C	94-102	
Electric System	Electrical System Voltage	V	24	
	Battery		Maintenance-free	
	Connecting Cables		Available	

Alternator **50Hz/1500R.P.M**

		Units	
General Data	Manufacture / Brand		Leroy-Somer
	Model		LSA 49.3 M6
	Coupling / No. of Bearings		Direct / Single Bearing
	Phase / Poles		3-Phase / 4-Pole
	Power Factor		Cos Φ = 0.8
	AVR Regulation		Yes
	Voltage Regulation		± 0,5 %
	Insulation Class		H
	Drip Proof		IP23
	Excitation		AREP
	Altitude	m	≤1000
	Overspeed	min ⁻¹	2250

Tide Power Easycon Function Summary

Controller Model / ComAp	EC 2.0 / Nano Plus	EC 3.0 / AMF20	EC 4.0 / AMF25	EC 5.0 / IG-NT
Controller Photos				
Standard Supply	×	●	○	○
Viewable Parameters				
Phase Voltage	×	3	3	3
Current	Instrumentation	●	●	●
Frequency	●	●	●	●
Active Power	×	●	●	●
Reactive Power	×	●	●	●
Apparent Power	×	●	●	●
Power Factor	×	●	●	●
Electric Energy Metering	×	●	●	●
Generator Protection				
Abnormal Voltage	●	●	●	●
Over-current Warning	×	●	●	●
Over current Protection	●	●	●	●
Over Frequency Protection	●	●	●	●
Short Circuit Protection	MCCB / ●	MCCB / ●	MCCB / ●	MCCB / ●
Engine Figure				
Oil Pressure	●	●	●	●
Water Temperature	●	●	●	●
Fuel Meter / Fuel Sensor	●/○	●/○	●/○	●/○
Speed	●	●	●	●
Battery Voltage	●	●	●	●
Elapsed Time	●	●	●	●
Engine Protection				
Low Oil Pressure Warning	×	●	●	●
Low Oil Pressure Protection	●	●	●	●
High Temperature Warning	×	●	●	●
High Temperature Protection	●	●	●	●
Overspeed Warning	×	●	●	●
Overspeed Protection	×	●	●	●
Alternator Charger	●	●	●	●
Functions				
Remote Start	●	●	●	●
AMF (Auto Main Failure)	●	●	●	●
Programmable Input	●	●	●	●
Programmable Output	●	●	●	●
Expand Module	×	○	○	○
Communication Function	×	○	○	● / RS232 / 485
Communication Port	USB	○	○	RS232 / 485
CAN	●	×	●	●
Service Indicate	×	×	●	●
Fault History	●	●	●	●
Gen-Gen Synchronising	×	×	×	●
Gen-Mains Synchronising	×	×	×	●

Remark: ● Standard Supply

○ Available as Optional

× Not Available

“Ensure a quieter life with our sound attenuation system.”

Features:

Extremely Rugged & Highly Corrosion Resistant Construction

- Body made from 2.0mm sheet steel components with powder coating
- 8-12 hours built-in fuel tank integrated into the skid-mount base
- Excellent design and craftsmanship
- Compact structure and longer service life
- Residential silencer to made sure the sound level.
- Zinc alloy with black powder coated locks and hinges and proven to withstand corrosive conditions.



Easy Commissioning and Maintenance

- Separate & Standing control room at end side, easy reachable electrical power connections, board.
- Side doors allowing 180° opening rotation .
- Radiator fill access through cover in canopy roof.
- Lube oil drain and radiator drain.
- Manual lube oil pump provided.

Security and Safety

- Earth leakage protection.
- 40-50mm non-inflammable sponge inside.
- Control panel viewing window in a lockable access door.
- Emergency stop button mounted on canopy exterior.
- Fuel fill and battery can only be reached via lockable access doors.
- Exhaust silencing system enclosed for operator safety
- Efficient management of cooling air to avoid high water temperature, reliable operation under harshest conditions.

Transportability

- Lifting points on top to move genset easily.
- Fork lift legs provided and easy to loose to fix the genset.

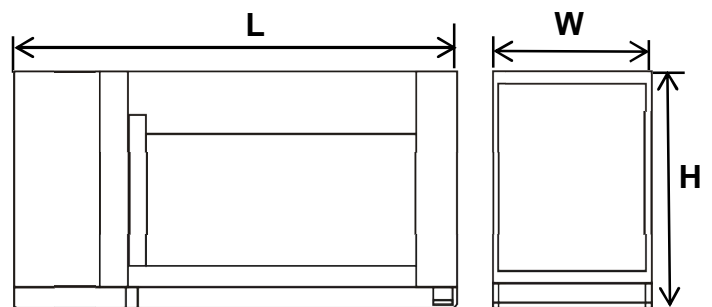

Overall Dimensions & Weight & Noice				
Dimensions	Weight	Noice Level	Base Tank @100% Load	
(L x W x H) mm	kg	dB(A) at 7m	Hours	Litres
5300x1900x2500	6500	65-78	N/A	N/A

Tide Power offers not only a changeover switch but also an integrated mains detection and switch system for your 24 Hour Power Protection. The system enables automatic start-up and operation of the generating set in the event of a mains power failure, overvoltage or loss of a mains automatic re-transfer once it come back.

System Advantages

- Automatically transfer and re-transfer load from main power to gen-power without operator intervention.operation (Both automatic and manual).
- ATS Controller (AMF function), seamless integration with AMF25
- Available from 32 – 4000A, better protection for 4 pole switch.
- Available in standard, bypass isolation and service-entrance configurations.
- Configurable in open, closed and programmed transition operating modes.
- Designed to interface seamlessly with TIDE POWER generators and switchgear.
- Drip proof IP42 enclosure.
- Easy installation: wall-mounted & floor standing
- Comes fully loaded with the technology to do the job.



50/60 Hz, 32-4000 Amps

Rated Current	Amps	32	63	80	100	125	160	200	250	300	315	400	630	800	1000	1250	1600	2000	2500	3200	4000A
Breaker Type	Chinese	x	A	x	A	x	B	x	C	x	x	C	C	D	D	D	D	E	E	E	x
	ABB	B	B	x	B	B	B	B	B	x	C	C	D	D	D	D	D	E	E	x	x
	Socomec	x	B	B	B	B	B	x	B	x	x	C	D	D	D	D	E	E	E	E	E

Dimensions : mm

A: 400x200x500 B: 500x300x650 C: 600x400x1200 D: 800x600x1400 E: 1000x800x1600

Optionals (All depends)

Custom-Made solutions

Genset:

Genset:

Materials & Miscellaneous

Materials & Miscellaneous

- Marine class painting and other special painting
- Standard accoustic enclosure genset
- Extended warranty
- Extended factory test
- Additional sensors
- Off road trailer type
- Standard ATS
- Mounted fire extinguisher
- Additional vibration isolation
- Wooden case packaging
- Tide Power tool kit
- Additional operation manual
- Nylon canvas wrapped packaging
- Iron shelf for double stack shipping
- Water jacket heater
- Additional CE features selection.

- On road trailer (EU) type
- Rental type genset
- Mining type genset
- Marine type genset
- High temp. Radiator for silenttype genset
- EPA series gensets

Optionals (All depends)

Diesel Engine/ Baseframe Mounted Accessories:

Cooling System

- Engine heat guards
- Low coolant level alarm & shutdown (Depends on engine series)
- High temp. & Anti-erosion radiator upgrade for open type genset
- 50% antifreeze @-36°C

Filters

- Extra air filters for time-maintenance
- Double heavy duty air filters
- Extra fuel filters for time-maintenance
- Extra oil filters for time-maintenance

Exhaust

- Residential silencer for open type genset
- Stainless steel silencer and kits
- Heat protection guard

Fuel & Oil

- Separated / External fuel tank
- Water - fuel separator
- 3 way fuel valve
- Manual bypass valve
- Lub oil make up tank
- Lub oil drain pump
- Fuel level sensor
- Fuel cooler
- Automatic remote fuel supply with fuel level switch & low fuel level alarm shutdown.
- Coolant heater 220/240V
- Lub-oil heater for severe cold weather

Starting & Charging

- Bulk starting battery -17°C below
- Battery removal switch
- Battery heater

Control System & Power Termination:

Control System & Breakers

- Different functional modules with
- Tide Easycon refer to other table
- Mounted audible and visible lighting
- Control panel cover (80kva or below)
- Motorized circuit breaker 3 Poles
- Motorized circuit breaker 4 Poles
- ACB 3 Poles
- MCCB 4 poles
- Different breaker brands, like ABB etc
- Leakage protection switch

Custom-Made solutions

Diesel Engine/ Baseframe Mounted Accessories:

Cooling System

- Anti-erosion radiator for silent type genset
- Remote radiator with heat exchanger
- Remote cooling tower with heat exchanger

Filters

- Mounted heavy duty air filter

Exhaust

- Mounted heavy duty air filter

Fuel & Oil

- Bulk base fuel tank
- Bunded base fuel tank

Starting & Charging

- None

Control System & Power Termination:

Control System & Breakers

- Various standard sockets mounted outside the enclosure

Optionals (All depends)

Brushless Alternator:

- 12 Lead stator (change voltage depends)
- Interchangeable S.A.E flanges and drive discs
- Convenient filters on air inlets and outlets
- Coastal type [] Alternator painting color P.M.G or auxiliary
- AREP for Leroy-Somer only
- Shunt trip
- Exterior potentiometer
- Auxiliary contacts and double bearing
- Anti-condensation heater
- Stator thermal protection
- Quadrature droop kits

Enclosure & Canopy:

Weather protective & Sound proof

- R series
- ISO 20ft containerized
- ISO 40ft containerized
- Stainless steel locks and hinges

Custom-Made solutions

Brushless Alternator:

- Temperature rise class F Marine type alternator IP upgrade HV

Enclosure & Canopy:

Weather protective & Sound proof

- Super silent enclosure
- Weather proof enclosure
- Flat sponge sound absorber enclosure
- Porous sheet with rockwool sound absorber enclosure

Please refer to Tide Power sales department for full details of the above options.

Warranty

Tide Power distributor, dealer, or authorized representative performs startup within 6 months of the date of shipment from the factory, warranty coverage will begin on the startup date (Register the startup date to Tide within 6 months is essential and can be enforced). This warranty does not apply to malfunctions caused by damages, unreasonable use, misuse, repair or service by unauthorized persons, or normal wear and tear.

Warranty Coverage

Generators used to commercial utility source:
One (1) year or 1000 hours (whichever occurs first) from date of shipment from the factory or registered startup date.